

PPI

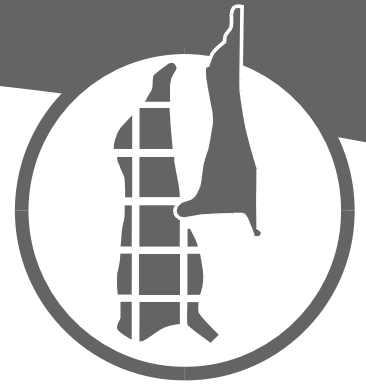

Biological Phosphorus Removal for Meat Processing Plants

PRENV.009

Prepared by:

Wastewater Futures Pty Ltd

PO Box 6306

St Lucia QLD 4067

Meat and Livestock Australia

Locked Bag 991

North Sydney NSW 2059

August 2003

ISBN – 1 74036 497 X

This publication is published by Meat & Livestock Australia Limited ACN 081678364 (MLA). Where possible, care is taken to ensure the accuracy of information in the publication. Reproduction in whole or in part of this publication is prohibited without the prior written consent of MLA.



MEAT & LIVESTOCK
AUSTRALIA

Executive Summary

This report is the final report that presents the results of Stage 1 & 2 of Project PRENV.009, 'Biological Phosphorus Removal for Meat Processing Plants'.

A literature review performed in 1999 (PRENV.003) evaluated several treatment options for nutrient removal from meat processing wastewater, and the preferred options for different scenarios were proposed. For plant upgrades and new plants, **the preferred option was a sequencing batch reactor (SBR) for secondary treatment**, after screening, dissolved air flotation (DAF) and an anaerobic pond. Consequently, the review recommended full-scale demonstration of bio-P removal using the sequencing batch reactor technology (SBR) to assess and optimise the effectiveness of this technology in the meat processing industry. It was also recommended that a comparison with chemical precipitation should be done in parallel in small scale using treated (for back-up installations) or untreated wastewater (as for cost-benefit evaluation). Chemical precipitation was recommended as a supplement for the biological phosphorus removal if low discharge limits had to be met consistently.

This work was performed at Australian Meat Holding's meat processing plant at Dinmore, QLD and in particular the two SBR's treating their effluent. The aims of the Stage 1 work were to evaluate a full-scale SBR for its nutrient removal capacity, investigate the operating conditions required for bio-P removal and to make recommendations for the Stage 2 work. Stage 2 was aimed at optimising the biological P removal performance (with no reduction in COD and N removal performance). Given the outcomes from Stage 1 it was proposed to focus Stage 2 on two issues. Firstly, to close the mass balance around the SBR (which could not be done in Stage 1) and secondly to optimise the SBR for biological phosphorus removal, within the existing system constraints.

The SBR process is a variation of the activated sludge process. Instead of operating with different basins, all process conditions are provided in the one tank, or in the case of AMH, one pond. The process conditions are varied in a controlled fashion over a period of time called a cycle. Specifically, the mixture of micro-organisms and wastewater is bubbled with air or oxygen for a period of time. This is followed by a period without mixing or aeration, to allow the biomass to separate from the treated wastewater. A portion of the treated wastewater is then discharged via the decant mechanism. The next cycle then begins with aeration and a new batch of influent wastewater is introduced into the tank.

The SBR's (4A & 4B) studied each have a volume of 8400 m³ (MWL), nominal hydraulic retention time of 3 days and a solids residence time (SRT) of 18 days. The effluent is decanted by a tilting plate type weir, which lowers during the decant phase.

A series of intensive sampling studies were performed to evaluate the nutrient removal performance of the SBR's, termed cycle studies in late October/early November 2001 as part of Stage 1. The SBR's were performing well in this period with greater than 96% nitrogen and COD removal and 50 – 70% phosphorus removal.

The results from these studies revealed that the phosphorus removal observed was largely due to 'standard' P uptake as a result of cell growth in the reactor as opposed to enhanced biological phosphorus removal. This was important, as it illustrated that under those conditions a large percentage of the phosphorus was used for growth purposes. This has not previously been reported at full-scale for meat process wastewater. It was possible to estimate the amount of P removal that was due to 'standard' growth processes and the amount due to enhanced bio-P removal. The phosphorus requirement for growth depends greatly on the VSS of the SBR and the sludge wastage rate. As sludge wastage is a limiting factor on this plant it is perhaps not surprising that a large percentage of available phosphorus was used for growth. Approximately 10 - 15% of the phosphorus removal observed in the SBR was due to enhanced bio-P removal. The performance was also similar to that observed

in the period April – September 2001 when no enhanced bio-P removal was occurring during a time of high effluent nitrate discharge.

Several opportunities to improve the bio-P removal were identified in Stage 1 and addressed in Stage 2. These were the sludge wasting strategy, ensuring adequate COD was available and also the configuration of the SBR cycle. For maximum bio-P removal the sludge should be removed from the SBR at the end of the aeration phase, when the cells have performed maximum uptake of phosphorus. In Stage 1, sludge wasting was performed continuously during the aeration phase due to equipment limitations. An upgrade to the sludge processing facilities was made in November 2002 to rectify this issue.

There were also significant opportunities for improving the SBR cycle. It is well known that for enhanced bio-P removal, the sludge needs to be cycled between anaerobic and aerobic conditions. The cycle operated during Stage 1 did not include an anaerobic period, although the original UniFed cycle did allow for this period. The cycle was modified in Stage 2 to include an anaerobic period.

Effluent $\text{NO}_x\text{-N}$ is also important in bio-P removal as we have encountered reduced bio-P removal when effluent $\text{NO}_x\text{-N}$ is greater than 10 mg/L. As a “rule of thumb”, for sewage treatment, $\text{NO}_3\text{-N}$ present during the anaerobic phase/reactor will reduce the P removal by 1 mg P/mg $\text{NO}_3\text{-N}$. Clearly, we can not afford to have much nitrate-N present during the anaerobic phase.

A further series of intensive sampling studies were performed in Stage 2 to evaluate the nutrient removal performance of the SBR, in May, October and December 2002. The SBR was performing well in this period with greater than 96% nitrogen and COD removal and 30% phosphorus removal.

In this study, a small step was made to improve the conditions for bio-P removal in a SBR that resulted in greater than 40% improvement in P removal. Nitrogen and COD removal were unchanged and were also excellent with greater than 96% removal.

Further work should aim to build on these findings, by optimising the SBR with the aim of maximising the bio-P removal whilst gaining a better understanding of the key operational parameters.

Abbreviations

AMH	Australian Meat Holdings Pty Ltd
APHA	American Public Health Association
BFP	Belt filter press
Bio-P	Biological phosphorus
Cts	Continuous
COD	Chemical Oxygen Demand
DAF	Dissolved air flotation
Eff	Effluent
FIA	Flow Injection Analyser
Inf	Influent
kg	kilogram
kL	Kilolitre
kL/d	Kilolitre per day
mg	milligram
mg/L	milligrams per litre
MLA	Meat and Livestock Australia
ML	megalitre
ML/d	megalitre per day
MRC	Meat Research Corporation
N	Nitrogen
NH ₄ -N	Ammonia nitrogen
NO ₂ -N	Nitrite nitrogen
NO ₃ -N	Nitrate nitrogen
NO _x -N	Oxidised nitrogen (ie. Nitrite + nitrate)
P	Phosphorus
PO ₄ -P	ortho-phosphate phosphorus
ppm	parts per million (equivalent to mg/L)
SBR	Sequencing Batch Reactor
SCOD	Soluble Chemical Oxygen Demand
SND	Simultaneous nitrification and denitrification
SRT	Solids retention time
TCOD	Total Chemical Oxygen Demand
TKN	Total Kjeldahl Nitrogen
TP	Total Phosphorus
TSS	Total Suspended Solids
VSS	Volatile Suspended Solids

Table of Contents

EXECUTIVE SUMMARY	I
ABBREVIATIONS	III
TABLE OF CONTENTS	IV
1 RECOMMENDATIONS FOR FURTHER WORK	1
2 INTRODUCTION	2
2.1 AIMS	2
2.2 BACKGROUND	2
Potential Industry Benefit	3
2.3 METHODOLOGY	3
3 THE SITE	4
3.1 SITE SELECTION	4
3.2 AMH DINMORE TREATMENT PLANT PROCESS DESCRIPTION	4
3.3 THE SBR	6
4 SBR STUDIES OF BIOLOGICAL PHOSPHORUS REMOVAL – STAGE 1	8
4.1 METHOD	8
4.1.1 <i>Sampling Points</i>	8
4.1.2 <i>SBR Sampling Regime</i>	8
4.1.3 <i>Flow Measurement</i>	8
4.1.4 <i>Analyses</i>	8
4.1.5 <i>Limitations</i>	9
4.2 CYCLE STUDY WEDNESDAY 31 ST OCTOBER 2001	9
4.3 SUMMARY OF STAGE 1 CYCLE STUDIES	10
4.4 CONCLUSIONS FROM STAGE 1 SBR STUDIES	12
5 OPTIMISING BIOLOGICAL PHOSPHORUS REMOVAL	13
5.1 ANALYSIS OF AMH DAILY SITE DATA	14
5.2 CONFIRMATION OF BIO-P REMOVAL	15
<i>SBR 4B May 2002</i>	15
<i>SBR 4A Benchmark October 2002</i>	16
<i>SBR 4A Bio-P Run #1 5th December 2002</i>	17
<i>SBR 4A Bio-P Run #2 18th December 2002</i>	18
5.3 CONCLUSIONS FROM STAGE 2 SBR STUDIES	18
APPENDIX 1 STAGE 1 CYCLE STUDIES	19
CYCLE STUDY FRIDAY 9 TH NOVEMBER 2001	19
CYCLE STUDY THURSDAY 15 TH NOVEMBER 2001	21
APPENDIX 2 MASS BALANCE	23

1 Recommendations for Further Work

This project has generated excellent data to support the further development of bio-P removal for meat processing wastewater. We have followed the development and optimisation of a full scale SBR for nitrogen and phosphorous removal that has routinely achieved 98% nitrogen removal and 30% phosphorus removal. The challenge is to further improve the P removal and to do this we need to better understand the variables influencing its behaviour.

Our approach to achieve this would be to work on a parallel path of modifying the operation of the full-scale SBR, in conjunction with controlled lab reactor batch studies to obtain the maximum bio-P removal. The full-scale plant is an important test bed for the industry, as it is subject to the full variability in operation of the upstream meat processing plant. The lab studies would entail comprehensive batch tests with the site wastewater and biomass to fully understand the bio-P processes. In this way we could manipulate variables such as the DAF effluent to anaerobic effluent feed ratio, DO set point, duration of the anaerobic and aerobic cycle periods etc. The laboratory batch tests also offer the opportunity to define the conditions and accurately measure the sludge yield, P release and uptake, VFA uptake and P content of the cells. The kinetic rates could also be determined to further support changes to the full-scale plant.

We believe this joint path would deliver considerable benefits to the meat processing industry, in improved bio-P removal from their wastewater and the conditions required to operate them.

2 Introduction

2.1 Aims

This report presents the findings of the MLA project PRENV.009 titled 'Biological Phosphorus Removal for Meat Processing Plants'.

The overall aims of the project were to:

- Identify the conditions necessary to achieve low values of phosphorus (P) in the effluent from a sequencing batch reactor (SBR) treating abattoir wastewater.
- Demonstrate successful P removal in a full-scale SBR unit treating abattoir wastewater.

The project was performed in two distinct stages. The aims of the Stage 1 work were to:

- Evaluate a full-scale SBR for its nutrient removal capacity.
- Investigate the operating conditions required for bio-P removal.
- Make recommendations for the Stage 2 work, which was aimed at optimising the biological P removal performance (with no reduction in COD and N removal performance).

The aims of the Stage 2 work were to:

- Optimise a full-scale SBR for its nutrient removal capacity, in particular P removal.
- Investigate the operating conditions required for bio-P removal and the factors influencing the P removal capacity.

Recommendations for future work were also made.

2.2 Background

This project follows on from the recommendations of the review entitled "Phosphorus Removal from Meat Processing Wastewaters". This review was conducted under contract to MLA, by Dr. Jurg Keller, Dr. Paul Lant and Mr Tim Hurse, of AWMTech Pty Ltd.

The review focussed on developments since 1993, the year of the last published survey of nutrient removal technologies in use throughout the industry (Johns, 1993). The main findings of the study were:

- Phosphorus removal technologies are available for the effective reduction of phosphorus in domestic and industrial wastewater.
- There is very little information available to assess the effectiveness or economics of these technologies for meat processing wastewater.
- Various phosphorus removal technologies have been demonstrated at full-scale for domestic wastewater. The selection of the method is often dependent on whether only phosphorus removal is required or whether nitrogen removal is also necessary.
- In domestic wastewater, the most common method for phosphorus removal in Australia is the biological phosphorus (bio-P) removal process, generally in combination with nitrogen removal also. However, if only phosphorus removal is required, chemical precipitation is commonly employed, particularly in Europe and the US.
- For meat processing wastewater, the only demonstrated method achieving consistent phosphorus removal is chemical precipitation, although this does not seem to have been used to date in Australia, most likely due to the significant costs for chemicals and the sludge disposal problem.
- The bio-P method has been shown to achieve good phosphorus removal from meat processing wastewater in small-scale systems, but has not been demonstrated at pilot or full scale at present.

The review evaluated several treatment options, and the preferred options for different scenarios were proposed. For plant upgrades and new plants, **the preferred option was a sequencing batch reactor (SBR) for secondary treatment**, after screening, dissolved air flotation (DAF) and an anaerobic pond. Consequently, the review recommended full-scale demonstration of bio-P removal using the sequencing batch reactor technology (SBR) to assess and optimise the effectiveness of this technology in the meat processing industry. It was also recommended that a comparison with chemical precipitation should be done in parallel in small scale using treated (for back-up installations) or untreated wastewater (as for

cost-benefit evaluation). Chemical precipitation was recommended as a backup for the biological phosphorus removal if low discharge limits had to be met consistently.

There are four publicly available reports about the use of the SBR concept to treat wastewater from Australian abattoirs (Green *et al.*, 1996; Keller *et al.*, 1997; MRC, 1997; Subramaniam *et al.*, 1994). One concerns a full-scale plant, another a demonstration-scale plant, and two deal with bench-scale investigations. In all cases, the effluent from an anaerobic pond formed the majority or totality of the influent to the SBR. While phosphorus removal was attempted in all systems, only the bench-scale reactors achieved a high degree of phosphorus removal whereas the full-scale system is reportedly achieving approximately 40% P removal.

The full-scale SBR (in Gippsland, Victoria) treats wastewater at an average flowrate of 250 m³/day. The average P concentration is reduced from 36 to 20 mg/L (Australian Meat Technology Pty Ltd and Polymers, 1999). Foaming, and incomplete nitrification were problems, but they were resolved during the commissioning phase. The treated wastewater is impounded and used either for irrigation, or for use within the yards (Green *et al.*, 1996). The demonstration-scale, optimised SBR (near Brisbane, Queensland) operated with a cycle time of 6 hours (MRC, 1997). Despite initial expectations and efforts, no significant P removal was observed. The absence of P-removal was conjectured to be due to an insufficient amount of soluble COD in the feed (from an anaerobic pond). Given the very unfavourable soluble COD to P ratios of 8-15 (minimal ratio required for domestic applications is 20), this is a likely cause of the difficulties encountered. This could also explain why the bench-scale reactors reported by Keller *et al.* (1997) and Subramaniam *et al.* (1994) did achieve a very high level of P removal (over 90% at times) while operating also on wastewater after anaerobic pre-treatment from the same abattoir. During the time of the bench scale tests, however, the soluble COD concentration in the wastewater was much higher and more favourable for P removal (soluble COD: P ratio generally >20 in the good P removal reactors). It was further demonstrated in these experiments that a lack of soluble COD (due to too much pre-treatment) does inhibit the P removal capacity dramatically.

Based on these observations, it can be concluded that the SBR process should be able to achieve a high level of P removal provided the influent wastewater characteristics are favourable. However, this has not yet been demonstrated at full scale. This was the aim of this project. Stage 1 of this project, completed in February 2002, determined that greater than 85% of P removal seen in the AMH SBR's was due to cell growth and not the enhanced biological phosphorous removal (EBPR) process. This was not surprising as the SBR was operated under conditions known to be not conducive to bio-P removal. Also, the effect of residual nitrate was demonstrated to have a significant effect on bio-P removal.

Potential Industry Benefit

The benefits to the meat processing industry of this work include:

- Identification of conditions leading to biological phosphorus removal in SBR units at full scale;
- Identification of typical effluent P values that can be achieved using this technology;
- An understanding of the issues that must be addressed to achieve biological phosphorus removal;
- Consistent reduction in effluent phosphorus loads from abattoirs;
- Knowledge of what performance can be realistically expected from modern SBR technology treating meat-processing effluent.

2.3 Methodology

The work was performed at the Australia Meat Holdings meat processing plant at Dinmore, Queensland. This study included a series of data collection exercises, to evaluate the biological removal of phosphorus in a full scale SBR.

Stage 1 of the project, performed in 2001, had the following aims:

- To evaluate a full scale SBR for its nutrient removal capacity
- To investigate the operating conditions required for bio-P removal.

Stage 2 was to be a repeat of Stage 1 with the express aim of modifying the operating conditions to determine what improvement in bio-P removal could be achieved. This report covers both stages of the work.

3 The Site

3.1 Site Selection

The first stage of this project entailed identifying an appropriate site for performing the data collection exercise.

The proposal targeted Australian Meat Holding's meat processing plant at Dinmore near Brisbane to be utilised in this project. This site was appropriate for this study for a number of reasons:

- Proximity to laboratories.
- Dinmore has the only full-scale SBR in Australia treating wastewater from a large-scale abattoir.
- A detailed pilot plant study of SBR technology was performed at Dinmore (MRC, 1997). The data from that work would be very useful for the full-scale investigations.
- The SBR at Dinmore is ideal to study because it has built-in flexibility to enable process optimisation. It is also a state-of-the-art design with a modern plant control system.
- Company interest in enhancing wastewater treatment.
- Previous successful collaboration with AMH

An initial site meeting was held at AMH on the 24th August 2001 with the AMH Group Engineering Manager Neil Brereton, Mike Johns from MLA and Paul Lant, Jurg Keller and Justin Doyle from Wastewater Futures P/L. After permission was granted to access the site, the treatment units were evaluated. During this evaluation, several sites were identified which could be sampled and which would represent the characteristics of the influent and effluent of the SBR. These were the anaerobic ponds that feed to the SBR, the belt press filtrate, the DAF effluent and the SBR itself.

The description of the AMH treatment plant follows.

3.2 AMH Dinmore Treatment Plant Process Description

The flowsheet of the AMH Dinmore wastewater treatment plant is shown in Figure 1. The screened abattoir wastewater is treated in two parallel save-alls. About 60% of the save-all effluent is treated in a primary DAF unit. The flow then passes to three parallel anaerobic ponds (Nos. 2, 2A and 3) followed by two sequencing batch reactors (SBR's – Ponds 4A and 4B) in parallel. Finally, the decanted SBR effluent flows through a facultative polishing pond (5) and a small aerated pond (5A) before discharge to the Bremer River.

Part of the DAF effluent (nominally about 20%) is pumped direct to the SBR's to supplement the COD available for nitrogen removal (ie. Denitrification). Waste sludge from the SBR's is de-watered on a belt filter press and then composted.

Effluent from Pond 5 is pumped for reuse within the abattoir site. First flush stormwater is pumped from Flush Pond B to Pond 3 for treatment with the wastewater before discharge to the river.

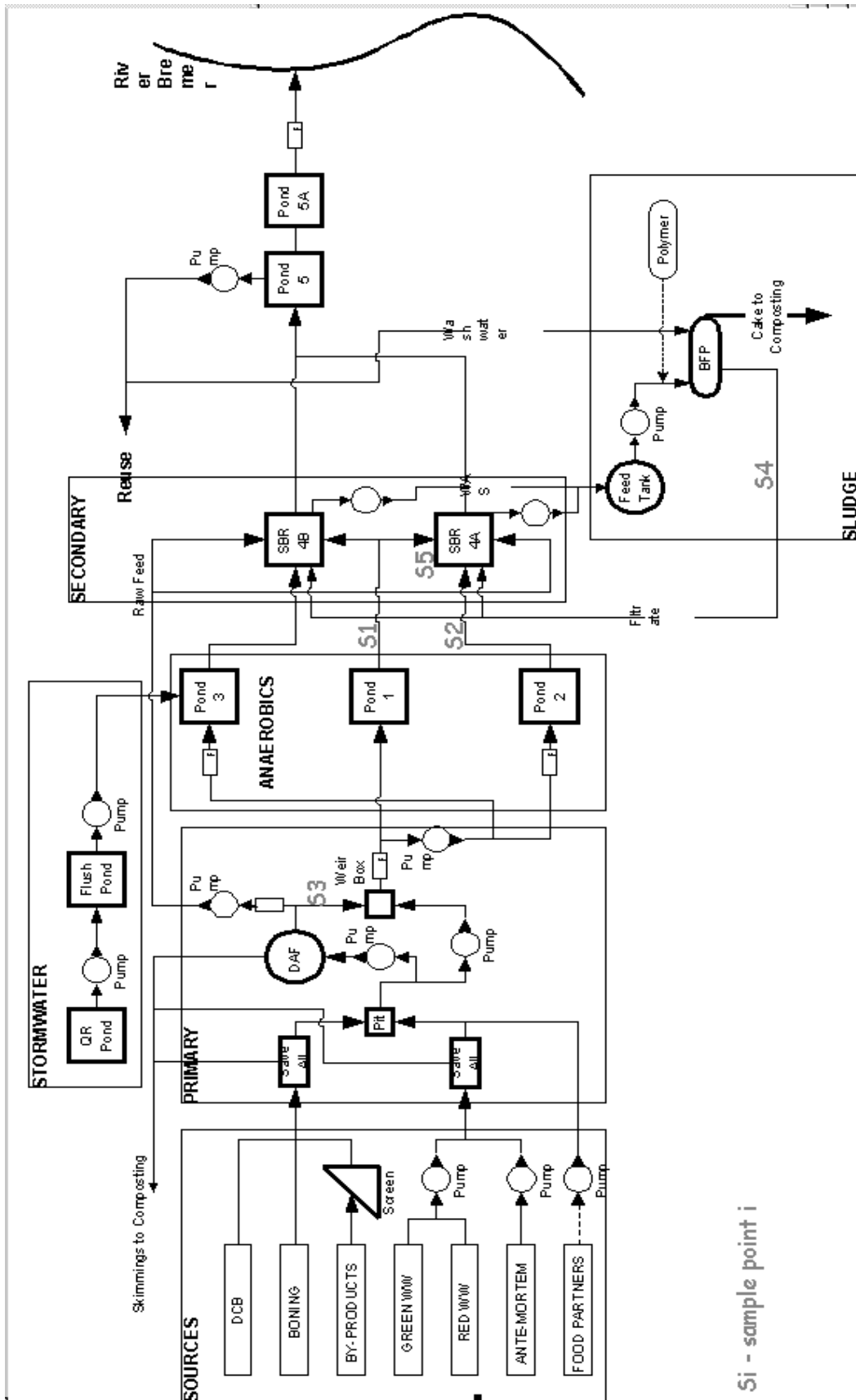

Si - sample point i

Figure 1. Dinmore wastewater treatment flowsheet.

3.3 The SBR

The SBR is where the biological nutrient removal process occurs and is thus the focus of this study. In particular, this study focused on SBR 4A (see Figure 1), although SBR 4B was also monitored.

The sequencing-batch reactor (SBR) process is a variation of the activated sludge process. Instead of operating with different basins, all process conditions are provided in the one tank, or in the case of AMH, one pond. The process conditions are varied in a controlled fashion over a period of time called a cycle. Specifically, the mixture of microorganisms and wastewater bubbled with air or oxygen for a period of time. This is followed by a period without mixing or aeration, to allow the biomass to separate from the treated wastewater. A portion of the treated wastewater is then discharged via the decant mechanism. The next cycle then begins with aeration and a new batch of influent wastewater is introduced into the tank. A representation of the SBR operation is shown in Figure 2.

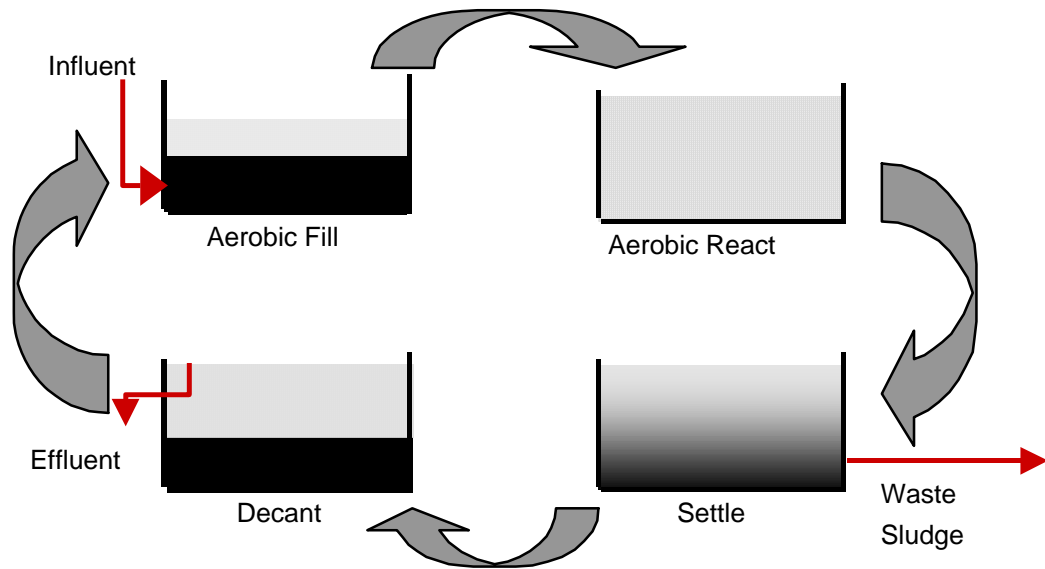

Figure 2. Schematic of SBR cycle sequence and operation

SBR 4A is shown in Figure 3. The SBR operates on a 6 hour cycle, consisting of 3 hr feed (which is aerated), and then 1.5 hr settle and 1.5 hr decant. Aeration is via surface aerators with dissolved oxygen control, set at 1 mg/L. The aeration is provided by six 75kW surface aerators.



Figure 3. SBR 4A

The SBR has a volume of 8800 m³, nominal hydraulic retention time of 3 days and a solids residence time (SRT) of 18 days. The effluent is decanted by a tilting plate type weir, which lowers during the decant phase (Figure 4).



Figure 4. SBR 4A decanting weir of tilting plate type

The SBR operation is complicated by the number of feeds entering it (Figure 1). The feed can be comprised of 4 different streams, namely the anaerobic pond 1 effluent, the anaerobic pond 2 effluent, the DAF effluent and the belt filter press filtrate, which all enter a mixing well prior to the inlet. Before commencement of Stage 2 a new anaerobic pond was constructed. This severely complicated the sampling program, which is discussed in the next section.

4 SBR Studies of Biological Phosphorus Removal – Stage 1

4.1 Method

A series of intensive sampling studies were performed to evaluate the nutrient removal performance of SBR 4A. The data collection was to be performed in two stages, the first of which has been performed and is described in detail here. The purpose of Stage 1 was to obtain some initial nutrient removal performance information for benchmarking, and to assess operational improvements to be incorporated for Stage 2.

4.1.1 Sampling Points

In order to determine the performance of the SBR, it is critical to know the feed concentrations and flow rate. In this particular case, this was complicated by the fact that the feed was comprised of four different streams, namely the anaerobic pond 1 effluent, the anaerobic pond 2 effluent, the DAF effluent and the belt filter press filtrate. All of these streams were sampled. The conditions in the SBR were monitored by sampling the mixed liquor.

The six sample points used in this study were (Figure 1):

- S1** - Anaerobic pond 1 effluent.
- S2** - Anaerobic pond 2 effluent.
- S3** - DAF effluent
- S4** – Belt filter press filtrate
- S5** – SBR 4A mixed liquor
- S6** – SBR 4A decanted effluent

4.1.2 SBR Sampling Regime

By its nature, the conditions in the SBR are time varying (dynamic). Therefore, in order to observe the key processes which are occurring, it is important to take frequent samples which enable us to observe the dynamics. These are referred to as intensive cyclic studies.

Cyclic studies on SBR 4A were performed on three separate occasions, Wednesday the 31st October, Friday the 9th November and Thursday the 15th November 2001 during the cycle period 1:07 pm - 7:07 pm. SBR 4A was selected for the intensive study. The mixed liquor of the SBR was sampled at 20 minute intervals throughout the 6 hour cycle. Sampling of the SBR was consistently taken from the eastern side of the landing. SBR effluent was also obtained at 20 minute intervals throughout the decant period (5:37 pm - 7:07 pm). Samples of influent from all sources were obtained throughout the feed period at 30 min - 1 hour intervals.

Approximately 1L of each waste stream was collected and an unfiltered sample (approx. 150 mL) was chilled immediately in crushed ice. Due to the high solids content it was not possible to filter the samples on site, but they were processed in the laboratory later that evening.

4.1.3 Flow Measurement

To obtain a mass balance over the SBR the volume of each feed stream and decanted effluent was required. This was determined from flowmeter readings and in the case of the belt press filtrate known pump rates.

4.1.4 Analyses

Analyses performed included total COD (TCOD), total kjeldahl nitrogen (TKN), total phosphorus (TP) and total and volatile suspended solids (TSS/VSS) for all influent streams and soluble COD (SCOD), ammonia, nitrate, nitrite and ortho-phosphate measurements for all influent, mixed liquor and effluent streams. Total and soluble COD were analysed using the Merck acid digestion and oxidation technique. The unfiltered samples were sonicated before the TCOD, TKN or TP analyses were performed. TKN and TP were performed via the acid digestion method followed by analysis by flow injection analyser (FIA).

Ammonia, nitrate, nitrite and ortho-phosphate were analysed via a FIA and were suitably diluted to bring the concentration within range. Total and volatile suspended solids were measured by the APHA standard method.

4.1.5 Limitations

Sample collection in an operational plant is often restricted by practical limitations. In this study, there were several practical complications that limited the study:

- Changes in the main plant meant that the influent characteristics during each intensive study period were different.
- Sample collection of the various influent sources could only be made with grab samples, as the proximity of the sampling point meant that use of an auto-sampler was not possible.

4.2 Cycle Study Wednesday 31st October 2001

An example of the data collected during stage 1 follows, with the remaining data from cycle studies performed on the 9th November 2001 and 15th November 2001 shown in Appendix 1.

Feed streams to SBR 4A on the 31st October consisted of effluent from anaerobic ponds 1 and 2, and the belt press filtrate. The effluent from anaerobic pond 2 was fed continuously into the SBR for three hours. The stream from anaerobic pond 1 was fed continuously into the SBR for the first hour, and then intermittently for 30 minutes at 30 minute intervals for the next two hours. Belt press filtrate was fed continuously to the SBR throughout the cycle. The SBR feed during this cycle was made up as shown in Table 1.

Table 1. Summary of Feed Inputs Cycle Study 31st October

Sample	Duration	TCOD mg/L	TKN mg/L	TP mg/L	Flow kL	N Load kg	P Load kg	COD Load kg
Anaerobic Pond 1	1 hr cts, then 30 min on and 30 min off for 2hr.	2,035	243	37.1	461	112	17.1	938
Anaerobic Pond 2	Cts for 3 hours	1,840	208	31.2	125	26	3.9	230
DAF effluent	Nil	Nil	Nil	Nil	Nil	Nil	Nil	Nil
BFP filtrate	Cts for 6 hours	2,032	39	29.6	125	4.9	3.7	254
TOTAL¹		2,000	201	34.7	711	142.9	24.7	1,422

¹ Total is calculated as the sum of the contribution from each feed source

Figure 5 shows the results from the SBR during the six hour cycle. The time shown on the x-axis is the actual time and not an elapsed time. There is a steady increase in nitrate concentration in the first 3 hours of the cycle, demonstrating nitrification during the feed and aerated period of the cycle. Ammonia remains at a very low level indicating that it is being nitrified as soon as it enters the SBR. No nitrite, an intermediate of nitrification and denitrification is seen in the cycle until the last 1.5 hours. The presence of nitrite at the end of the cycle is most likely due to denitrification occurring in the settle/decant period. The graph displays oxidised nitrogen results as NO_x-N, which is the sum of nitrite and nitrate (NO_x-N minus nitrite gives the nitrate concentration). The soluble COD concentration varies during the feed part of the cycle most likely due to the on/off feeding of the anaerobic pond 1 effluent. The concentration of phosphate decreases during the feeding and aerobic part of the cycle, consistent with phosphorus uptake. During the settle/decant stage, the phosphate concentration increases as a result of phosphorus release under anaerobic conditions in the sludge blanket.

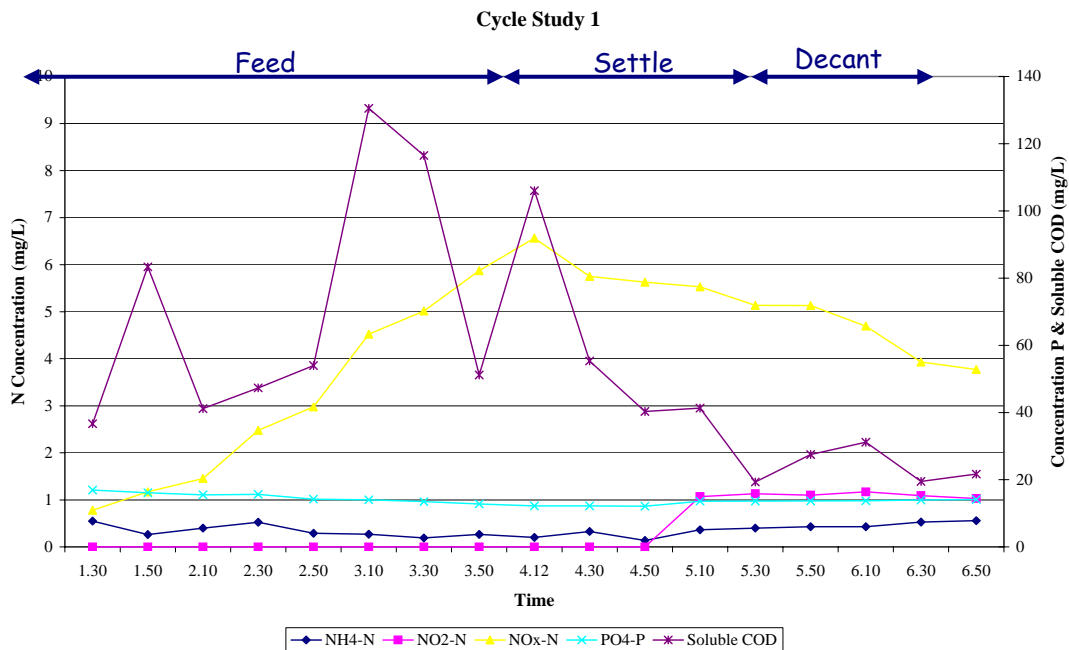

Figure 5. SBR 4A Cycle study 31st October.

In this cycle, no bypass of DAF effluent (raw wastewater) directly to the SBR was made. This was due to higher than normal effluent COD from the anaerobic ponds. The feed streams from anaerobic ponds 1 and 2 were similar throughout the feed period for all inorganic nutrients, COD and suspended solids. The belt press filtrate however, sampled on 2 occasions throughout the cycle, showed significantly different values for total COD, TKN, TP and suspended solids. This was a difficult location to obtain samples and the filtrate quality was clearly changing, observed by the degree of suspended solids in the sample.

Efficient nitrogen, phosphorous and COD removal was obtained in the cycle period with the effluent concentrations much reduced as compared to the influent (Table 2). Inorganic nitrogen (NO_x-N) remained at low but measurable levels in the SBR with a definite peak in nitrate concentration at the end of aeration (Figure 5). Soluble COD fluctuated throughout the cycle period, but was substantially reduced by the end of the cycle. There was good phosphate uptake during the aeration phase with some increase in concentration during the settle/decant phase.

Table 2. Biological Nutrient Removal Performance on 31st October

	Average Total Nitrogen (TN)	Average Total Phosphorous (TP)	Average Total COD
Combined Feed *	201 mg/L	35 mg/L	2,000 mg/L
SBR 4A Effluent	7.7 mg/L	13.8 mg/L	75 mg/L
% Removal	98%	60%	96%

* (Pond 1 + Pond 2 + Filtrate)

On the availability of the accurate level data, we will perform nitrogen and phosphorus balances over the SBR to show where the nutrients go.

4.3 Summary of Stage 1 cycle studies

It is important to note that the phosphorus removal was largely due to 'standard' P uptake as a result of cell growth in the reactor as opposed to enhanced biological phosphorus removal. This is important, as it illustrates that under the operating conditions at the time, a large percentage of the phosphorus was used for growth purposes. This has not previously been reported at full-scale for meat process wastewater. It is possible to estimate the amount of P removal that is due to 'standard' growth processes and the amount due to enhanced bio-P removal. The phosphorus requirement for growth depends greatly on the VSS of the SBR and the sludge wastage rate. As sludge wastage is a limiting factor on this plant it is perhaps not surprising that a large percentage of available phosphorus is used for growth. Approximately

10 - 15% of the phosphorus removal observed in the SBR was due to enhanced bio-P removal. The performance is also similar to that observed in the period April – September 2001 when no enhanced bio-P removal was occurring during a time of high effluent nitrate discharge.

This is typical of an industrial wastewater treatment plant operating with differing feed conditions. Under these conditions, the SBR was performing remarkably well with greater than 96% nitrogen and COD removal and 50 – 70% phosphorus removal.

Greater variation is seen in phosphorus removal than nitrogen removal, which is typical and reflects the complexity of the process and the sensitivity to changing operating conditions.

Table 3. SBR Biological Nutrient Removal Summary

	Cycle 1			Cycle 2			Cycle 3		
	Inf	Eff	% Rem	Inf	Eff	% Rem	Inf	Eff	% Rem
Total Flow kL	711	711	N/a	396	396	N/a	361	361	N/a
N Load¹	143	2.6	98	90.1	1.7	98	81	3.3	96
P Load¹	24.7	9.8	60	20.7	10	52	21	6.4	69
COD Load¹	1422	53.2	96	2033	36	98	1577	29.8	98
COD:N	9.9:1			22.6:1			19.5:1		
COD:N:P	58:5.8:1			98:4.3:1			76:3.9:1		

(¹ Load numbers are expressed as kg units)

Table 3 summarises the performance of the SBR on the three test occasions. A high and stable level of COD and nitrogen removal of > 96% was seen with good but variable phosphorus removal of 52 – 69%. This demonstrates that there is scope for improving biological phosphorus removal whilst demonstrating substantial P removal. Most research on bio-P removal to date has been performed on domestic wastewater where influent phosphorus levels rarely exceed 15 mg/L, whereas levels encountered here ranged from 30 – 60 mg/L. The design and operation of this SBR has demonstrated a high level of nutrient removal capacity in an area that has been not the focus of research.

The studies have also confirmed the occurrence of simultaneous nitrification denitrification (SND), particularly in the later 2 cycle studies, shown in Appendix 1. SND typically occurs in low DO environments, of 1 mg/L and less. The use of surface aerators can promote SND as the DO profile can vary significantly in the SBR with low or no DO, even with the contents well aerated and well mixed. SND is advantageous as long as nitrification is not affected due to the greater time available for denitrification and use of COD for this purpose rather than aerobically.

Several opportunities to improve the bio-P removal were identified, and were addressed in Stage 2 of this project. These were:

- 1. The sludge wasting strategy.** For maximum bio-P removal the sludge should be removed from the SBR at the end of the aeration phase, when the cells have performed maximum uptake of phosphorus. In its current configuration, sludge wasting is performed continuously during the aeration phase due to equipment limitations. Plans exist to upgrade the sludge processing facilities to rectify this issue.
- 2. Adequate TCOD.** A key figure used as a rule of thumb for nitrogen removal is the TCOD:TKN ratio. A minimum ratio typically quoted is 10:1 and on the 31st October the TCOD:TKN ratio was less than this figure. The results show that on this occasion a higher level of NO_x-N remained in the effluent. In the November studies the TCOD:TKN ratio was approximately 20:1 and the effluent NO_x-N remained very low at less than 1 mg/L. Effluent NO_x-N is important in bio-P removal as we have encountered reduced bio-P removal when effluent NO_x-N is greater than 10 mg/L. As a “rule of thumb”, for sewage treatment, NO₃-N present during the anaerobic phase/reactor will reduce the P removal by 1 mg P/mg NO₃-N. Clearly, we can not afford to have much nitrate N present during the anaerobic phase.
- 3. The SBR cycle.** There are significant opportunities for improving the SBR cycle. It is well known that for enhanced bio-P removal, the sludge needs to be cycled between anaerobic and aerobic conditions. The Stage 1 cycle does not include an anaerobic period, although the original UniFed cycle did allow for this period.

4.4 Conclusions from Stage 1 SBR Studies

The Stage 1 study investigated the nutrient removal performance, in particular phosphorus, of a sequencing batch reactor (SBR).

Table 4. SBR Biological Nutrient Removal Summary

	Cycle 1			Cycle 2			Cycle 3		
	Inf	Eff	% Rem	Inf	Eff	% Rem	Inf	Eff	% Rem
N Load¹	143	2.6	98	90.1	1.7	98	81	3.3	96
P Load¹	24.7	9.8	60	20.7	10	52	21	6.4	69
COD Load¹	1422	53.2	96	2033	36	98	1577	29.8	98

(¹ Expressed in kg)

This study revealed that significant phosphorus removal is achievable in full-scale SBR's treating meat process wastewater. The remaining question was how much bio-P removal can be achieved? In this study, a sub-optimal SBR (cycle was not designed for optimising phosphorus removal) provided up to 69% P removal, which is significant. Nitrogen and COD removal were also excellent with greater than 96% removal.

Stage 2 work aimed to build on these findings, by optimising the SBR with the aim of maximising the bio-P removal, without having a detrimental effect on the BOD and nitrogen removal performance.

5 Optimising Biological Phosphorus Removal

Stage 2 of this project presented the opportunity to manipulate some of the major control handles of the SBR with the intent to optimise the enhanced biological phosphorus removal. The major control handles that could be manipulated were:

- Solids residence time (SRT).
- Wastewater make-up, varying the soluble COD: P ratios in the feed wastewater.
- SBR cycle period and times.
- Sludge wasting strategy
- Dissolved oxygen concentration.

We identified the SBR cycle as offering the most suitable first step in improving the bio-P removal, in particular incorporating an anaerobic period at the start of the cycle in conjunction with feeding. The sludge wasting strategy was also modified to better suit the bio-P process, but this arose due to AMH upgrading the waste sludge processing equipment at the same time of the cycle change.

The existing cycle configuration was 3 hr feed with aeration and then 3 hr settle, incorporating the last 1.5hr as decant, depicted below.

Existing Cycle

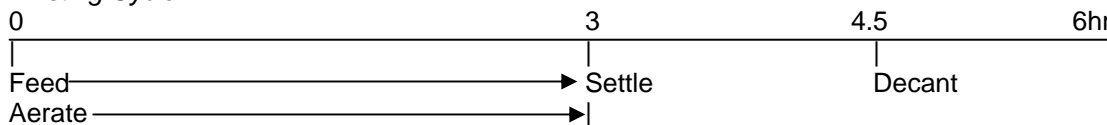

For enhanced bio-P removal, the sludge needs to be cycled between anaerobic and aerobic conditions. The current cycle did not include an anaerobic period, although the UniFed cycle did allow for this period. An anoxic/anaerobic period at the start of feeding followed by aeration, settle decant was implemented, of an initial duration of 30 min as shown below.

Modified Cycle

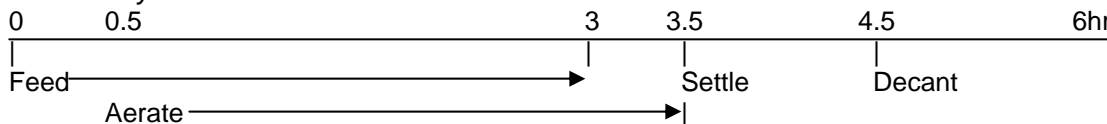

In the new cycle the settle period was shortened by 30 min to incorporate the shift in aeration (maintained at 3 hr) and the inclusion of a 30 min anaerobic period at the start of feeding. Feeding duration remained unchanged at 3 hr. A further benefit here was that at the end of feeding, 30 min of aeration remained to ensure all ammonia and COD was oxidised.

The DO set-point of 1.5 mg/L was maintained as this seemed to promote simultaneous nitrification and denitrification, particularly in SBR 4A, which was beneficial. The sludge age was also not changed, as we wanted to ensure nitrification performance was not compromised. Sludge wasting however, was made at the very end of the aeration phase in the minimum timeframe of 1hr, whereas previously this took 3hr. This was made possible with improvements in the sludge processing equipment at AMH, including aeration of the sludge in a holding tank prior to processing in a belt filter press.

The “modified cycle” shown above was implemented to SBR 4A only. However, a knock-on effect was made in that a reduction in the DAF effluent flow to SBR 4B resulted, of approximately 17%. This meant that this extra DAF flow entered SBR 4A. The modified cycle changes to SBR 4A were performed over the period the 29th November to the 2nd December 2002.

Prior to the modifications a benchmark study was performed on the 17th October 2002. Routine daily monitoring by AMH continued and detailed studies of SBR 4A were performed by our team on the 5th and the 18th December 2002.

5.1 Analysis of AMH Daily Site Data

Each day, samples of all waste streams are collected by AMH personnel and analysed in their laboratory. This data was used to trend the nutrient removal performance of the SBR's through detailed analysis. Daily COD and nutrient loads were calculated for each day and the average of these for the periods January 1st 2002 – November 30th 2002 and December 2002 used for comparison.

Both SBR's data was analysed, as SBR 4B had been shown to not have any bio-P removal at all in a previous cycle study (22nd May 2002). SBR 4A however, had shown some limited bio-P removal in the Stage 1 study. All summarised data is shown in Table 5.

Table 5. Summary of AMH Plant Data January – December 2002

SBR	Average Influent					
	MLSS mg/L	Flow ML/d	COD kg/d	N kg/d	P kg/d	P mg/L
SBR 4A						
Jan – Nov 2002	6,580	1.9	5,620	489	95	44.8
Dec 2002	6,090	2.1	7,500	530	114	55.0
SBR 4B						
Jan – Nov 2002	6,390	2.6	7,020	676	129	43.8
Dec 2002	6,290	3.1	7,900	751	163	53.1

SBR	Average Effluent				P Removed as	
	NH ₄ -N mg/L	NO _x -N mg/L	PO ₄ -P mg/L	SS mg/L	PO ₄ -P mg/L	% Change
SBR 4A						
Jan – Nov 2002	3.3	2.6	28.5	20	15.6	
Dec 2002	4.2	2.8	31.9	24	22.3	43%
SBR 4B						
Jan – Nov 2002	2.2	24.3	31.7	23	10.2	
Dec 2002	2.6	26.7	41.2	31	11.5	12%

The data in Table 5 clearly shows that with the modification to the SBR operation, improved phosphorous removal was observed in both SBR's, although the improvement in 4B was negligible relative to the variability in the results. SBR 4A however, showed a significant improvement of 40% despite the effluent P concentration increasing slightly. This increase in the effluent was due to a significant increase in the influent P concentration from 44.8 to 55 mg/L.

The flow, COD and nutrient loads in December were 10 – 30% increased over the rest of the year, again indicating the good gains seen in P removal, despite the system being under increased pressure, both hydraulically and loading wise. The COD:N and COD:P ratios were also very similar in the two periods with SBR 4A recording 13 and 64 (Jan-Nov '02) and 14 and 67 (Dec '02) respectively. For the same period SBR 4B recorded 11 and 56 (Jan-Nov '02) and 11 and 50 (Dec '02) respectively.

This data also confirms that the extra P removal is not due to growth. The MLSS and COD loading in each SBR is very similar and since they are operated at the same sludge age (18 days), they should both therefore remove the same amount of P if it was due to growth. SBR 4B did not previously show any bio-P removal, so the 11.5 mg/L effective P removal can be assumed to be for growth purposes only, which is approximately 20-25% of the TP. Therefore, SBR 4A with an effective P removal of 22.3 mg/L for the same period represents a near 100% improvement, with the extra P removal being due to enhanced biological phosphorous removal (EBPR).

The cycle studies performed also confirm the EBPR process was occurring in SBR 4A, and are detailed in section 5.2.

5.2 Confirmation of Bio-P Removal

Benchmarking exercises on the two SBR's at Dinmore were performed to determine nitrogen and phosphorus removal performance. SBR 4B had shown very little capacity for P removal, whereas SBR 4A had shown some bio-P removal, as reported in Section 4.

SBR 4B May 2002

On the 22nd May 2002 a benchmarking study on SBR 4B was performed by sampling the flows into and out of the SBR as well as the mixed liquor in the SBR over the course of the 6 hr treatment cycle. Samples were collected every 15min from the SBR itself as well as numerous samples of the various in-flows to the SBR. Influent to SBR 4B comes from anaerobic ponds 2B and 3 plus DAF effluent. Filtrate from the belt press also enters the pond continuously. Samples were analysed for ammonia, nitrite, nitrate and phosphate and COD. The results are shown in Table 6 and Figure 6.

Table 6. Summary of Feed Inputs Cycle Study 22nd May

Sample	Duration	NH ₄ -N mg/L	PO ₄ -P mg/L	Flow kL	N Load kg	P Load kg
Anaerobic Pond 2B	Cts for 3 hours	215	36	207	51.9	8.3
Anaerobic Pond 3	Cts for 3 hours	200	32	155	35.9	5.4
DAF effluent	Cts for 3 hours	80	33	58	19.2	2.1
BFP filtrate ¹	Cts for 6 hours	N/a	4	130	N/a	0.3
TOTAL²		145	30	550	107	16.1

¹ Concentration is the difference between the WAS and BFP concentrations

² Total is calculated as the sum of the contribution from each feed source

Figure 6 demonstrates SBR 4B's capacity for nitrogen and phosphorus removal. Considering the known feed loads of nitrogen, with no biological removal of nitrogen (assuming that is the only significant process occurring) we would expect the NH₄-N to be approximately 11 mg/L at the end of the three-hour feed period.

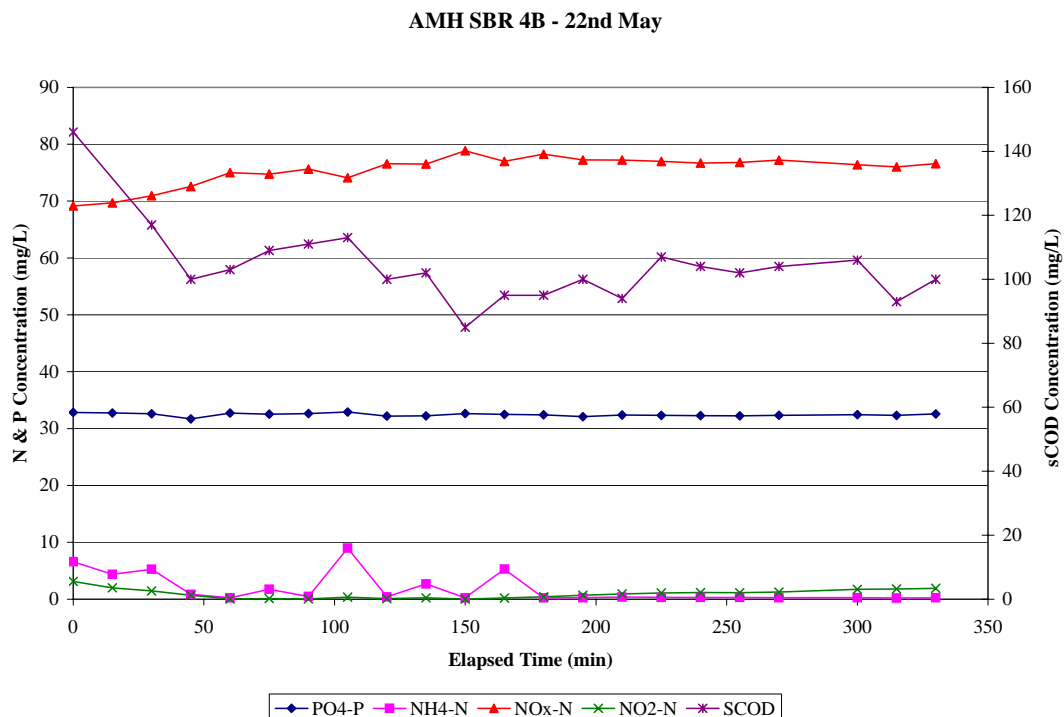

Figure 6. Cycle Study of SBR 4B on Wednesday 22nd May 2002

Efficient nitrification (ammonia oxidation) was obtained throughout the cycle period (Figure 6), however a significant concentration of nitrate remained at the end of the cycle, affecting the overall nitrogen removal from this SBR (Table 7). Only 60% nitrogen removal was achieved when previous studies on SBR 4A had shown greater than 97%. This indicates that there was a problem with denitrification in 4B, most likely related to COD in the feed to this SBR. Soluble COD was observed to decrease throughout the cycle, however the phosphorous concentration did not reduce, possibly due to the high nitrate concentration and sub-optimal conditions on this occasion. The presence of nitrate in the SBR at concentrations greater than 5 – 10mg/L impact significantly on phosphorus removal, as has been witnessed here.

Previous studies on SBR 4A had shown simultaneous nitrification and denitrification (SND) occurring, as no nitrate was measured during aeration. In this cycle of 4B there appears to be no SND as nitrate is clearly seen to increase during aeration, by approx. 10 mg/L, the equivalent ammonia feed concentration. SND typically occurs if a low DO is sustained in the SBR during the aerobic stage. With no SND, the denitrification capacity of the SBR would be reduced.

Table 7. Biological Nutrient Removal Performance on 22nd May

	Average Total Nitrogen (TN)	Average Total Phosphorous (TP)
Combined Feed ¹	195 mg/L	30 mg/L
SBR 4A Effluent	77 mg/L	32.5 mg/L
% Removal	60 %	0 %

¹ (Pond 2B + Pond 3 + DAF effluent + Filtrate)

Figure 6 also clearly shows that no bio-P removal or EBPR is occurring in SBR 4B, as the phosphorous concentration does not change during the cycle. This study enabled us to quantify a system with no bio-P removal operating under similar conditions to a SBR with some bio-P removal (SBR 4A).

SBR 4A Benchmark October 2002

Prior to the operational changes made in November/December 2002, another benchmarking study was performed on SBR 4A, as it was exhibiting a small amount of bio-P removal. This study was performed on the 17th October under the same operating conditions to 4B. The results are shown in Figure 7.

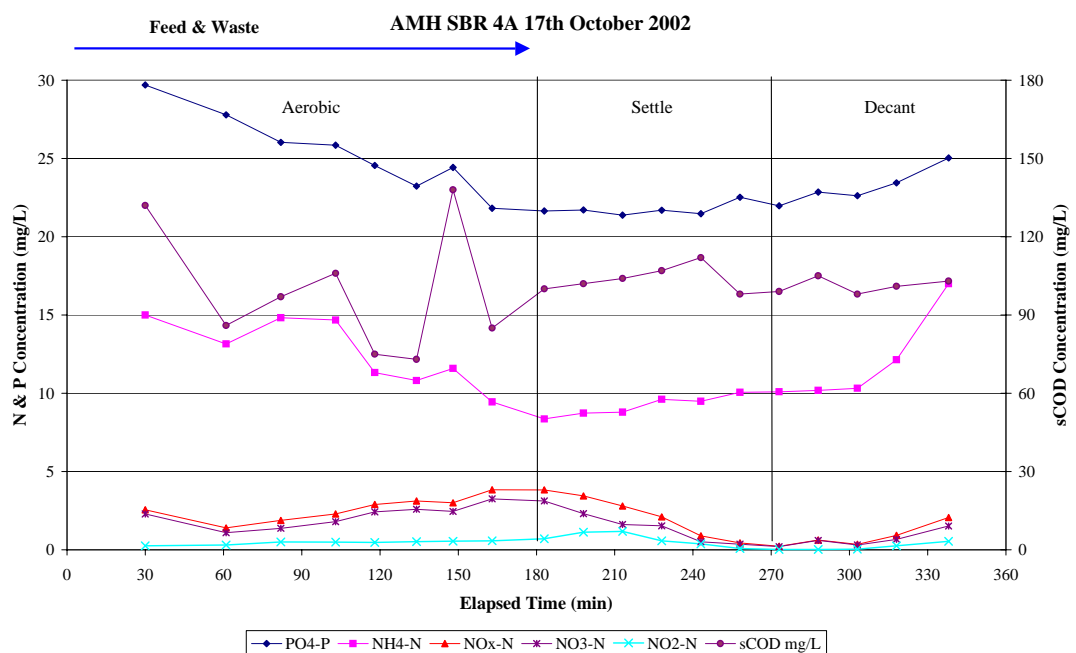

Figure 7. Cycle study on SBR 4A 17th October 2002, prior to modifications.

This cycle clearly demonstrates that EBPR was occurring in this SBR, under the non-optimised operating conditions as witnessed by the large reduction in P concentration during the aerobic stage of the cycle. This cycle had no true anaerobic period, however during the settle/decant period the system would become anaerobic in the sludge blanket as the residual NO_x-N concentration was very low to begin with and would reduce further under these conditions. The P concentration also began to increase in the settle/decant phase, indicating P release, which only occurs under anaerobic conditions.

Figure 7 also confirms that SND was still occurring, as the nitrate concentration does not increase by the same amount as the decrease in ammonia during the aerobic period. This is a clear indication of SND behaviour.

As Bio-P was shown to be present prior to modifying the cycle operation, we were able to quantify the improvement these modifications made to P removal. The Subsequent studies on SBR 4A on the 5th and 18th December further demonstrated the mechanisms of bio-P removal as shown in Figures 8 & 9.

SBR 4A Bio-P Run #1 5th December 2002

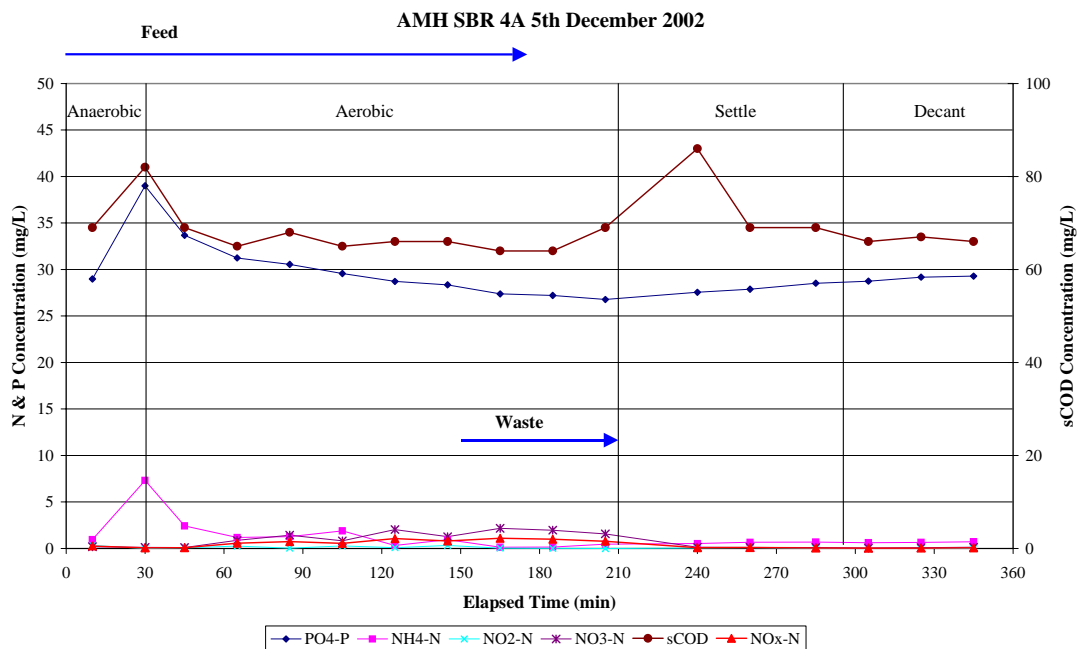

Figure 8. Cycle study on SBR 4A 5th December 2002, just after modifications

During the anaerobic phase an increase in the ammonia concentration of 6 mg/L is observed due to the incoming feed. The P concentration in the same period, however increased by 11 mg/L in 30 min, which can only be due to bio-P release and not as a result of the incoming feed P, which is less than 1/5th the influent nitrogen concentration. Upon commencement of aeration, the P concentration decreases rapidly in the first hr, and continues at a slower rate for the rest of the aerobic phase.

Nitrogen removal was not affected by these cycle changes, and SND was still occurring given the lack of nitrate during the aerobic period when the ammonia was being oxidised. The P concentration also began to increase slowly during the settle/decant phase indicating that the sludge had entered anaerobic conditions in the settled sludge blanket.

SBR 4A Bio-P Run #2 18th December 2002

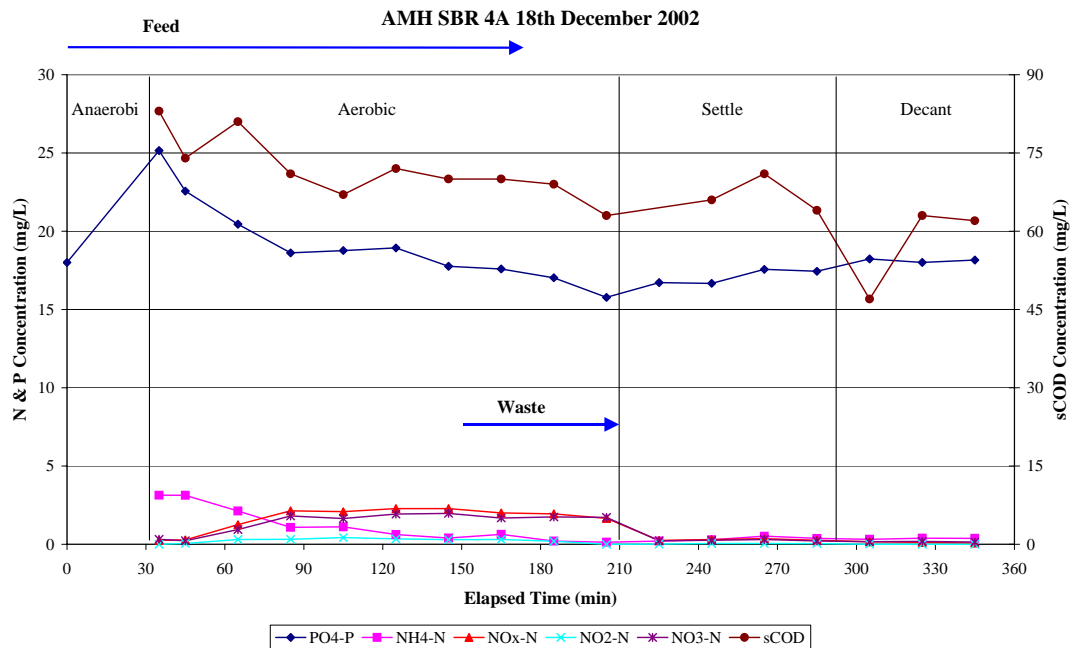

Figure 9. Cycle study on SBR 4A 18th December 2002

Figure 9 shows a very similar profile to Figure 8 and again confirms the presence of bio-P removal. The P concentration increased by 8 mg/L during the anaerobic period, when the ammonia concentration increased by less than 4 mg/L. The amount of P release is related to the amount of VFA in the feed.

Wasting sludge at the end of aeration in the shortest timeframe ensures the maximum amount of phosphorus had been taken up by the biomass. The two charts above clearly show the benefit of this waste strategy versus wasting for the entire aeration period, in ensuring the biomass have enriched as much P as possible.

5.3 Conclusions from Stage 2 SBR Studies

This study has revealed the gains in phosphorus removal possible in a full-scale operating SBR treating meat process wastewater, given the right operating conditions. The remaining question is how much bio-P removal can be achieved? In this study, a small step was made to improve the conditions for bio-P removal in a SBR that resulted in greater than 40% improvement in P removal. Nitrogen and COD removal were also excellent with greater than 96% removal.

Further work should aim to build on these findings, by optimising the SBR with the aim of maximising the bio-P removal whilst gaining a better understanding of the key operational parameters.

Appendix 1 Stage 1 Cycle Studies

Cycle Study Friday 9th November 2001

Feed streams to SBR 4A on the 9th November consisted of effluent from anaerobic pond 1, DAF effluent and the belt press filtrate. The streams from Pond 1 and the DAF effluent were fed continuously into SBR 4A for three hours. Belt press filtrate was fed continuously to SBR 4A throughout the cycle. The SBR feed during this cycle was made up as shown in Table 11.

Table 11 Summary of Feed Inputs Cycle Study 9th November

Sample	Duration	TCOD mg/L	TKN mg/L	TP mg/L	Flow kL	N Load kg	P Load kg	COD Load kg
Anaerobic Pond 1	Cts for 3 hours	2,608	256	37	125	32	4.7	326
Anaerobic Pond 2	Nil	Nil	Nil	Nil	Nil	Nil	Nil	Nil
DAF effluent	Cts for 3 hours	5,315	257	39	146	37.5	5.7	776
BFP filtrate	Cts for 6 hours	7,440	166	83	125	20.7	10.4	930
TOTAL¹		5,131	228	52.5	396	90.2	20.8	2,032

¹ Total is calculated as the sum of the contribution from each feed source

Figure 16 demonstrates the SBR's capacity for nitrogen and phosphorus removal. All species of nitrogen remain at less than 1 mg/L throughout the cycle.

Considering the known feed loads of nitrogen, with no biological removal of nitrogen (assuming that is the only significant process occurring) we would expect the NH₄-N to be approximately 11 mg/L at the end of the three hour feed period. The very low values observed clearly illustrate how effective the nitrification (ammonium oxidation process) is. Also, because there is little NO_x-N observed, which is the product of nitrification, we can also conclude that significant denitrification is also occurring during the 'aeration' phase. This process is called simultaneous nitrification and denitrification (SND). SND can occur if a low DO is sustained in the SBR during the aerobic stage.

The phosphate concentration decreases during the aerobic feed period, when incoming phosphate is also entering the SBR demonstrating that P uptake is occurring at this stage. Again a small increase in phosphate concentration occurs during the settle/decant period.

Cycle Study 2

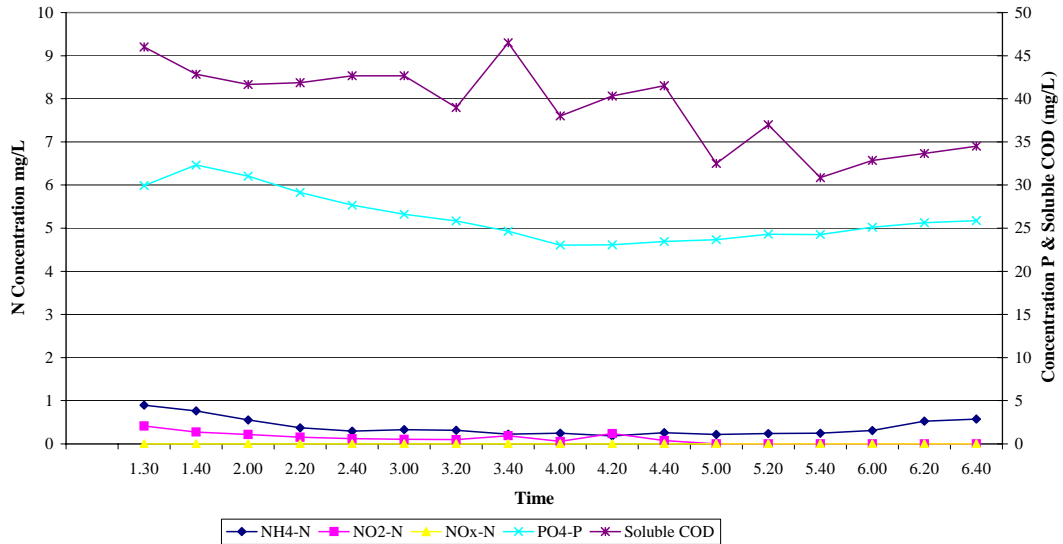

Figure 16. SBR 4A Cycle study 9th November.

In this cycle a raw feed (DAF effluent) bypass to the SBR had been re-employed as effluent from anaerobic pond 2 was being used to fill a new anaerobic pond. This would have left the SBR influent deficient in COD without the addition of DAF effluent. The feed streams from anaerobic pond 1 and the DAF effluent were consistently similar throughout the feed period for inorganic nutrients, COD and suspended solids. The belt press filtrate was sampled on 2 occasions throughout the cycle and showed significantly different values for total COD. Again the earlier comments regarding the filtrate apply here.

Efficient nitrogen removal was obtained throughout the cycle period (Table 12) with inorganic nitrogen remained at less than 1 mg/L throughout the cycle (Figure 16). Phosphorous and soluble COD were observed to decrease throughout the cycle, however phosphorous levels were not reduced to levels from the cycle studies performed on the 31st October or 15th November, due to the much higher influent P concentration on this occasion.

Table 12. Biological Nutrient Removal Performance on 9th November

	Average Total Nitrogen (TN)	Average Total Phosphorous (TP)	Average Total COD
Combined Feed *	228 mg/L	52.5 mg/L	5,131 mg/L
SBR 4A Effluent	4.3 mg/L	25.3 mg/L	91 mg/L
% Removal	98%	52%	98%

* (Pond 1 + DAF effluent + Filtrate)

Cycle Study Thursday 15th November 2001

Feed streams to SBR 4A on the 15th November consisted of effluent from anaerobic pond 1, raw wastewater, and the belt press filtrate. The streams from Pond 1 and the DAF effluent were fed continuously into SBR 4A for three hours. Belt press filtrate was fed continuously to SBR 4A throughout the whole cycle. The SBR feed during this cycle was made up as shown in Table 13.

Table 13. Summary of Feed Inputs for Cycle Study 15th November

Sample	Duration	TCOD mg/L	TKN mg/L	TP mg/L	Flow kL	N Load kg	P Load kg	COD Load kg
Anaerobic Pond 1	Cts for 3 hours	2,624	199	34.4	125	24.9	4.3	328
Anaerobic Pond 2	Nil	Nil	Nil	Nil	Nil	Nil	Nil	Nil
DAF effluent	Cts for 3 hours	4,610	142	28.8	146	20.8	4.2	673
BFP filtrate	Cts for 6 hours	4,600	282	98.4	125	35.3	12.3	575
TOTAL¹		3,980	205	52.5	396	81	20.8	1,576

¹Total is calculated as the sum of the contribution from each feed source

The results depicted in Figure 17 differ from the others in that higher ammonia concentrations occur throughout the cycle. The ammonia is reduced from nearly 12 mg/L at the cycle start to just over 2 mg/L at the end of aeration. No nitrate or nitrite was measured during aeration indicating simultaneous nitrification and denitrification has occurred, as seen in the previous study. The phosphate concentration is slightly reduced from the start to finish of the cycle, indicating phosphorus removal. The large increase in ammonia and COD at the end of the cycle is attributed to a problem upstream that led to a quantity of high strength wastewater entering the SBR at this time.

Cycle Study 3

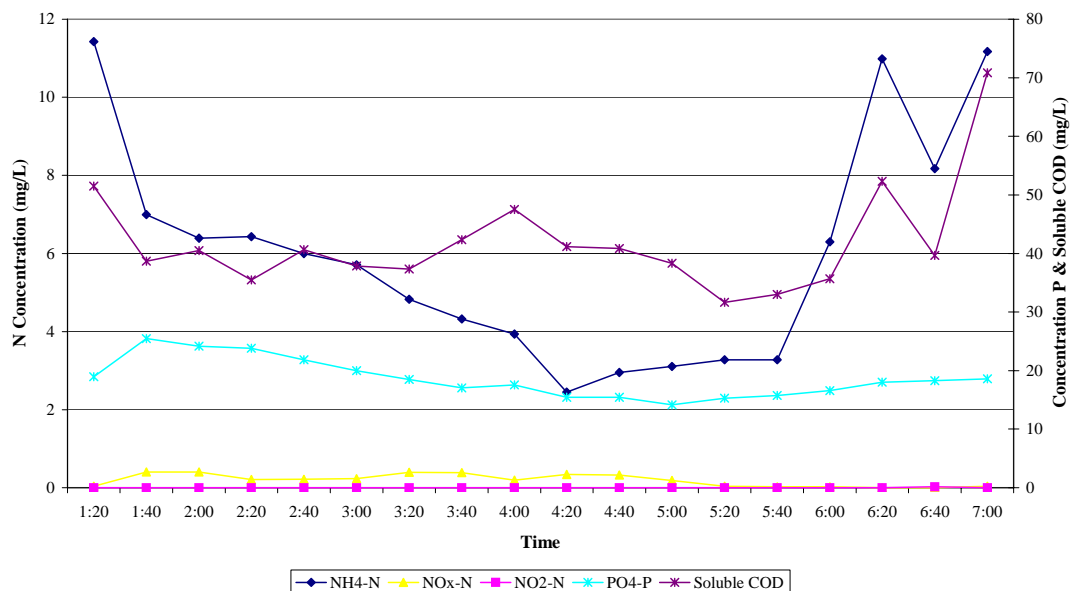

Figure 17. SBR 4A Cycle study 15th November.

This result clearly illustrates the benefit of performing intensive cyclic studies. If only the effluent data was available (ie. from the end of the cycle during decant), we may conclude that the SBR performance is quite poor. However, given the detailed data from the whole cycle, it is very easy to see how well the SBR is performing, and also to explain why the effluent concentrations are high.

The operating conditions on this day were the same as the 9th November. The feed streams from anaerobic pond 1 and the DAF effluent were consistently similar throughout the feed period for all inorganic nutrients. Samples taken at 4:15 pm for the raw feed differed markedly from previous measurements that day for COD and suspended solids. Earlier, the filtration system on the killing floors had malfunctioned, which most likely explains the higher concentration of COD and suspended solids present in the raw wastewater. The large increase in soluble COD and ammonia towards the end of the cycle may reflect this event (Figure 8). The belt press filtrate was sampled on 3 occasions throughout the cycle and once again showed variable measurements for total COD, total and volatile suspended solids.

Efficient nitrogen removal was obtained throughout the cycle (Table 14) and inorganic nitrogen remained at very low levels throughout the cycle (Figure 17). Phosphorous and soluble COD were observed to decrease throughout the cycle until 5pm, where levels began to increase. Effluent total nitrogen was higher than previous occasions most notably due to the large increase in ammonia during the settle/decant period. At this stage of the cycle no conversion to nitrate was possible, as no oxygen was present.

Table 14. Biological Nutrient Removal Performance on 15th November

	Average Total Nitrogen (TN)	Average Total Phosphorous (TP)	Average Total COD
Combined Feed *	205 mg/L	53 mg/L	3,980 mg/L
SBR 4A Effluent	9.2 mg/L	17.9 mg/L	83 mg/L
% Removal	96%	69%	98%

* (Pond 1 + DAF effluent + Filtrate)

Appendix 2 Mass Balance

One of our aims in the second stage of the project was to accurately determine the P removal of the SBR's, by closing the mass balance on the system. In stage 1 this was not possible due to uncertainty around the volume change of the SBR, however this was resolved in Stage 2 through the level sensor output from the SBR.

Further analysis of the mass balance however, uncovered another critical issue for the phosphorous balance, and that was the sludge wasting process. To elaborate further, the mass balances for the cycle studies are presented in Tables 13 & 14 and illustrated in Figure 18.

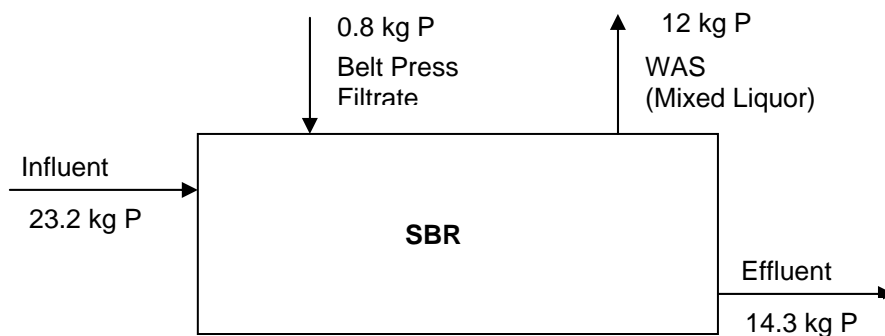

Figure 18. SBR 4A Mass Balance schematic, 5th December 2002.

Figure 18 shows that the P inputs were received from the influent, comprising DAF effluent and anaerobic pond effluent and the belt press filtrate. The input from the BPF was calculated as the net difference between that leaving the SBR in the WAS stream and what returned in the BPF. There was typically a small increase in ortho-P concentration from the WAS to BPF streams as well as some solids not captured on the belt.

Phosphorous outputs were the belt pressed waste solids and the effluent.

Table 13. Mass Balance calculations for SBR 4A on the 5th December 2002

Stream	P Concentration mg/L	Flow kL	Load kg
Pond 2A	46.9	392	18.4
DAF Effluent	48.2	100 ¹	4.8
BP Filtrate	6.7 ²	120 ³	0.8
Total In			24
WAS	96 ⁴	125	12
Effluent	29	492	14.3
Total Out			26.3
Change in P			-2.3

¹ DAF effluent flowed for 2.5hr only. Based on 125kL per cycle over 3hr.

² P Concentration of BPF based on difference between [PO₄-P] of the WAS and BPF

³ Estimate of return flow based on 125kL WAS volume per cycle, less press solids.

⁴ P content of sludge based on 2% VSS.

Table 13 represents the data collected from a single intensive cycle study, in which the volumes and concentrations of the streams into and out of the SBR are determined as accurately as possible. This reveals that the approach is flawed, as despite the best efforts the system does not balance. In effect, we overestimate the P removed.

Table 14. Phosphorus balance over single SBR treatment cycles

Date	In (kg)		Out (kg)		P Removed (kg)
	P Influent	P BPF	P WAS	P Effluent	
22 nd May	30.5	0.6	14.6	26	-9.5
17 th Oct	20.4	0.2	14	11.6	-5.0
5 th Dec	23.2	0.8	12	14.3	-2.3
18 th Dec	14.4	0.6	12.8	8.3	-6.1

All units are kg

As Table 14 above shows, the mass balance approach overstates the P removal by a significant amount in every case. This was determined to be due to uncertainty in the sludge waste stream flow and the significant variability in solids capture on the belt filter press. It is unlikely that this can be resolved, but in light of the daily monitoring data, the importance of the mass balance is minimal.